

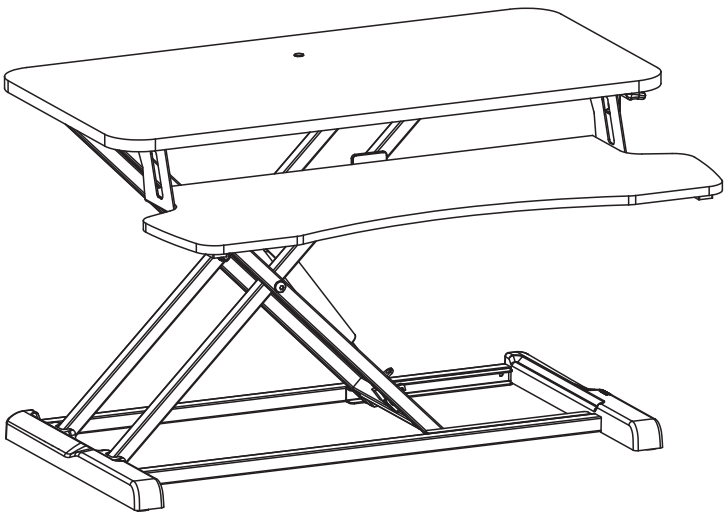

Desk Riser Instruction Manual



SKU: DESK-V000K/KA/KF/KG/KN/KO/KR/KW



Scan the QR code with your mobile device or follow the link for helpful videos and specifications related to this product.

<https://vivo-us.com/products/desk-v000k>

GET IN TOUCH | Monday-Friday from 7:00am-7:00pm CST



help@vivo-us.com



www.vivo-us.com
Chat live with an agent!



309-278-5303

WARNING!

If you do not understand these directions, or if you have any doubts about the safety of the installation, please call a qualified technician. Check carefully to make sure there are no missing or defective parts. Improper installation may cause damage or serious injury. Do not use this product for any purpose that is not explicitly specified in this manual and do not exceed weight capacity. We cannot be liable for damage or injury caused by improper mounting, incorrect assembly, or inappropriate use.

WARNING: CHOKING HAZARD

SMALL PARTS - NOT FOR CHILDREN UNDER 3 YEARS. ADULT SUPERVISION IS REQUIRED.

PACKAGE CONTENTS



A (x1)
Desk



B (x1)
Keyboard Tray



C (x1)
Stopper



D (x3)
Pad



E (x4)
Rubber Feet



F (x2)
Cable Clip



S-A (x2)
ST4.2x12mm Screw



S-B (x4)
M5x10mm Screw

TOOLS NEEDED



Scissors



Phillips
Screwdriver

DO NOT EXCEED WEIGHT CAPACITY.
Failure to do so may result in serious injury.



DESKTOP



KEYBOARD TRAY

WARNING: PINCH POINT

DO NOT place hands on or near support bars. Moving parts can crush and cut. Pinch points are created during lifting and lowering the work surface. Failure to follow these instructions may result in serious personal injury.

ASSEMBLY STEPS

STEP 1

Apply Pads (D) to underside of Keyboard Tray (B). Assemble Stopper (C) to Keyboard Tray (B) using ST4.2x12mm Screws (S-A) and a Phillips screwdriver.

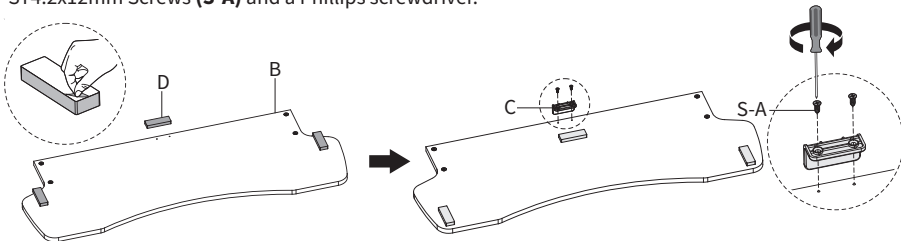

STEP 2

Install Rubber Feet (E) to the bottom of Desk (A). Then cut the large shipping tie. **NOTE: DO NOT** squeeze the handle on Desk (A) while cutting the shipping tie.

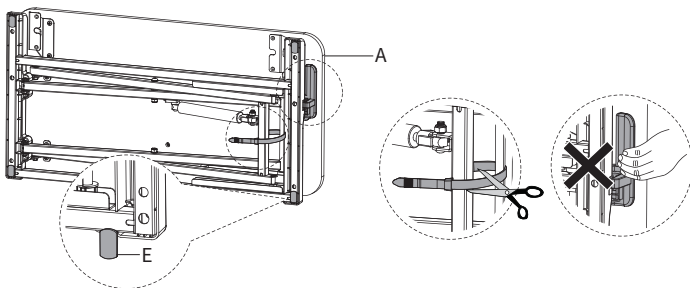

STEP 3

Raise Desk (A) by lifting the handle on the right side of the frame.

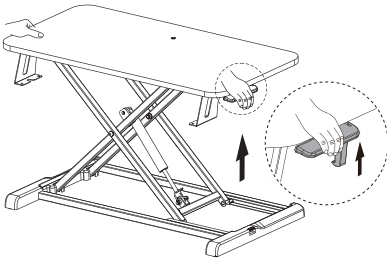

STEP 4

Place Keyboard Tray (B) on the metal brackets on Desk (A). Secure Keyboard Tray (B) to brackets using M5x10mm Screws (S-B) and tighten with a Phillips screwdriver.

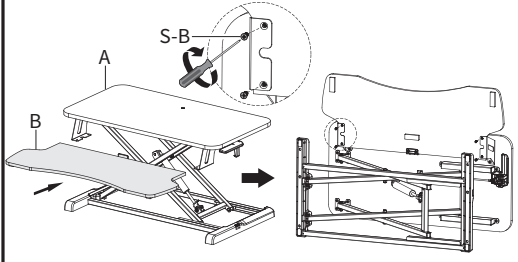

STEP 5

Apply Cable Clips (F) to underside of Desk (A).

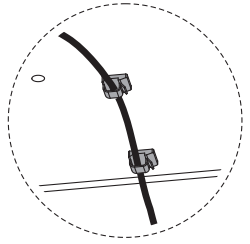
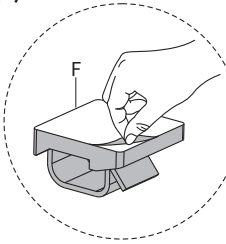
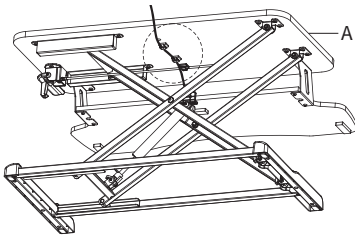

STEP 6

If installing a monitor mount, remove the plug from the desktop, then secure the mount using grommet mounting hardware included with your monitor mount.

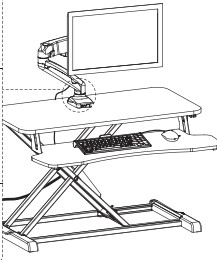
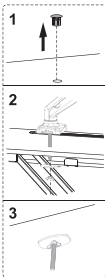

CAUTION!



Keep monitor and laptop base fully on the desktop.



Follow the cable routing instructions to avoid the potential to pinch cables.



Leave enough slack in cable to allow for full range of vertical motion (15" / 38 cm).



Raise desktop slowly to keep items stable.

Failure to follow these instructions may result in property damage and/or personal injury.



Love your new VIVO setup and want to share?
Tag us in your photo! [@vivo_us](#)

LAST UPDATED: 02/8/2023
REV3.1



Open **Monday - Friday 7:00am - 7:00pm** CST,
our dedicated support team can offer immediate assistance with rapid response times. If any parts are received damaged or defective, please contact us. We are happy to replace parts to ensure you have a fully functioning product.



309-278-5303

AVG. RESOLUTION TIME (*within office hrs*): **5M 4S**



www.vivo-us.com
Chat live with an agent!

AVG. RESOLUTION TIME (*within office hrs*): **< 15 M**



help@vivo-us.com

AVG. RESPONSE TIME (*within office hrs*): **1HR 8M**

- 23% within < 15m
- 38% within < 30m
- 61% within < 1hr
- 83% within < 2hr
- 92% within < 3hr

FOR MORE VIVO PRODUCTS, CHECK OUT OUR WEBSITE AT: www.vivo-us.com